

SÉRIE 29.100

INTERRUPTORES DE TECLA

ESPECIFICAÇÕES:

CARACTERÍSTICAS ELÉTRICAS : 15A com carga resistiva em 120VCA ou 10A com carga resistiva em 250VCA. (Contato Q)

RESISTÊNCIA DE CONTATO: máximo de 20 miliohms com aplicação de 1A em VCC.

RESISTÊNCIA DE ISOLAMENTO: mínimo de 1.000 megaohms.

RIGIDEZ DIELÉTRICA: 1.000V(RMS) para 1 minuto (mínimo).

TEMPERATURA DE OPERAÇÃO: 0° a 55°C.



REFERÊNCIAS

| Referência | | |
|------------|------|--------|
| 29101 | LIGA | LIGA |
| * 29123 | LIGA | DESL |
| 29129 | LIGA | (DESL) |

* Possíveis opções c/ lâmpada 110/250 VCA.
Obs.: outras tensões sob consulta

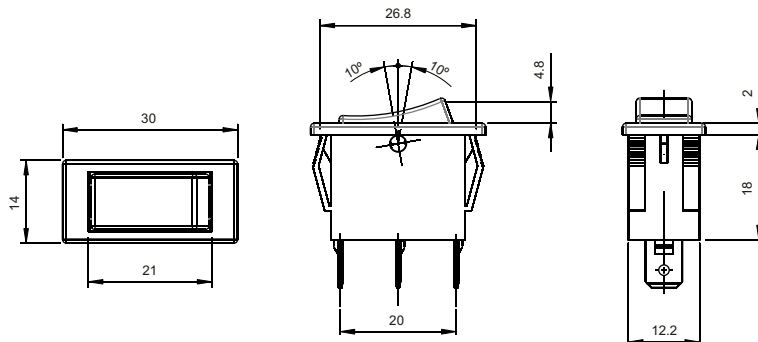

MOLDURAS

M1# - 14,0 x 30,0 (Standard)

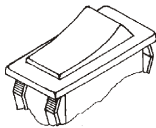

M3# - 16,0 x 31,0

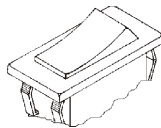

M4# - c/ capa protetora

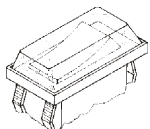

ATUADORES

T1# - tecla com lâmpada

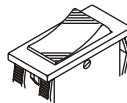

T2# - tecla

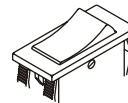

T3# - tecla com lâmpada

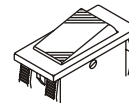

T4# - tecla

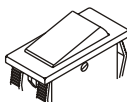

T5## - tecla com lente

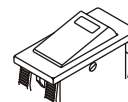

T6## - tecla com lente

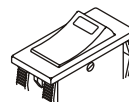

TERMINAL

E3 - faston 6,3 x 0,8

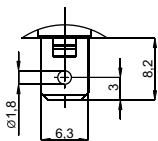

CONTATOS

S - Standard

4A com carga resistiva em 120VCA

2A com carga resistiva em 250VCA

B

10A com carga resistiva em 120VCA

6A com carga resistiva em 250VCA

Q

15A com carga resistiva em 120VCA

10A com carga resistiva em 250VCA

G

20A com carga resistiva em 120VCA

15A com carga resistiva em 250VCA

- CORES

Obs.: Substituir # pelo código da cor desejada.

A - azul

B - branco

C - amarelo

D - verde

E - vermelho

F - preto - (standard)

G - cinza

H - marrom

RASGO PARA ENCAIXE

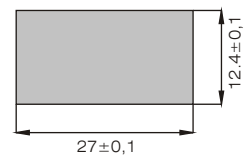

BARRA DE CODIFICAÇÃO



Referência



moldura



atuador



terminal



contato

M1#

M3#

M4#

T1#

T2#

T3#

T4#

T5##

T6##

E3

S

B

Q

G

Obs.: As teclas T5 e T6 possuem visor luminoso. É necessária a codificação de duas cores, sendo a primeira para tecla e a segunda para o visor.

Ex.: T5FE - tecla preta com visor vermelho.