

CONTROL FOR FANS

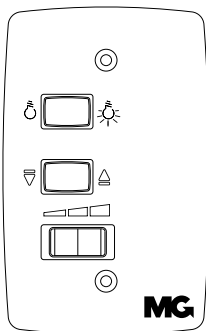

- Used for drive and speed control ceiling fans with combined lamps.
- Individual models for 127VAC and 220VAC.
- Provided with capacitor.
- 1 year of warranty.
- Maximum power of 200W.

MODELS:

CONTROL 1 - 127VAC

CONTROL 2 - 220VAC

PANEL MARKING:

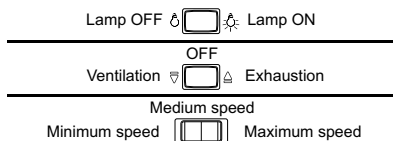
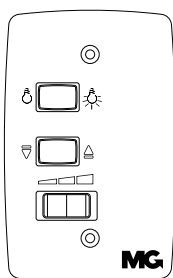

INSTALLATION INSTRUCTIONS

WARNING: Before connecting, check in the fan instructions if the power and capacitor are compatible with the values below:

Voltage	Maximum power	Capacitor
127V~	200W	4+6 μ F/250VAC
220V~	200W	1,3+2,3 μ F/250VAC

- Before starting the installation, ensure that the power is off (circuit breaker off).
- Check the connection scheme suitable for the installation, according to figures below.
- Follow the exact schedule of connection, confronting with the scheme provided by the manufacturer of the fan.
- For doubts in connection scheme, consult a qualified person or our technical department.

Note: If the fan is operating contrary to the indication of the button fan/exhaust, reverse the black wires connection that leaving off the control.

VOLTAGE

- 1 - 127VAC
- 2 - 220VAC

WIRING DIAGRAM

Connection with single switch:

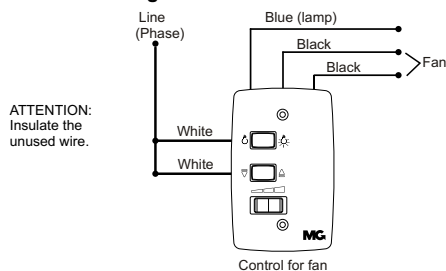

Connection with three-way switch (phase in switch):

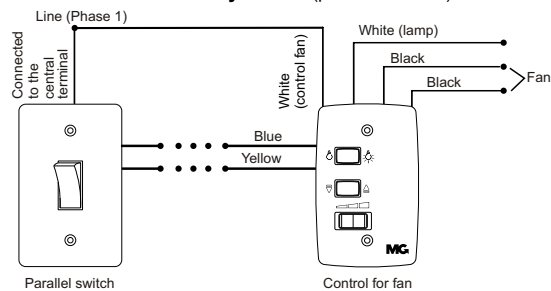

Connection with three-way switch (phase in control for fan):

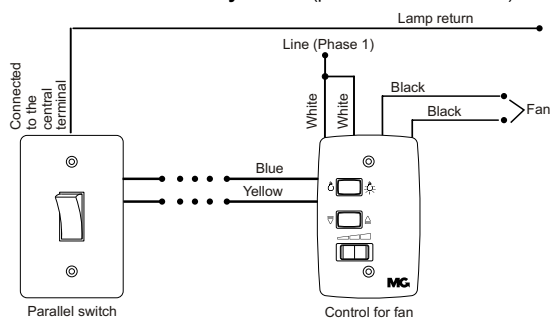

Typical configuration of fans:

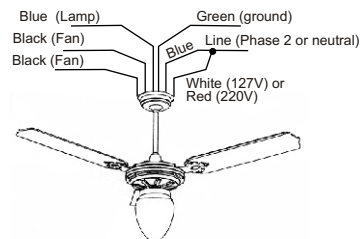

Check the fan's instructions because there may be changes in the wire color and / or other specifications.

SELECTION GUIDE

CONTROL

Model	Voltage
1	127VAC
2	220VAC