

CABLE TRUNKING AND ACCESSORIES

For protecting cables in electrical installations in residential, commercial and industrial environments.

Made from self-extinguishing PVC.
Sliding cover with precise fittings.
High adhesion double-sided tape.



REFERENCES	
CAN	Cable trunking
CXC	Flat cross
CXT	Flat tee
CT9	Flat bend
CTE	External bend
CTI	Internal bend
CLV	Coupler
DRV-ES	Flush-mounted to surface-mounted converter

DIMENSIONS

Cable trunking 20x10 mm

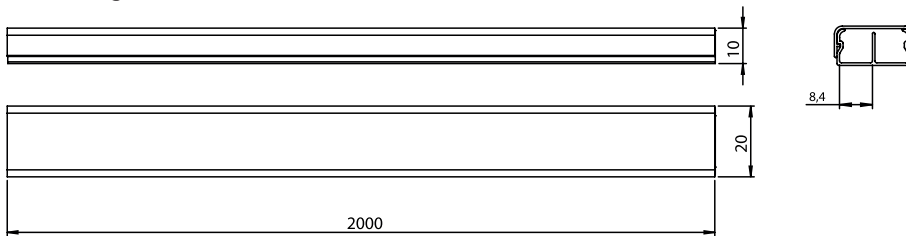

Accessories 20x10 mm

Flat cross

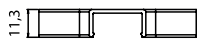

Flat tee



Flat bend 90°

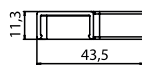

External bend

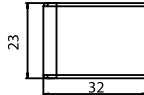

Internal bend

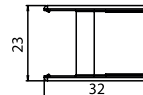

Coupler

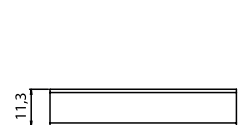
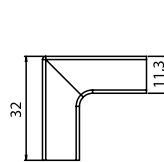
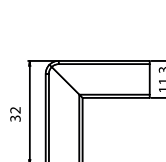
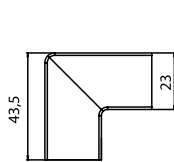
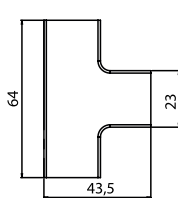
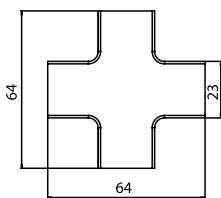
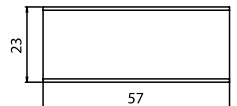

Cable trunking 40x16 mm

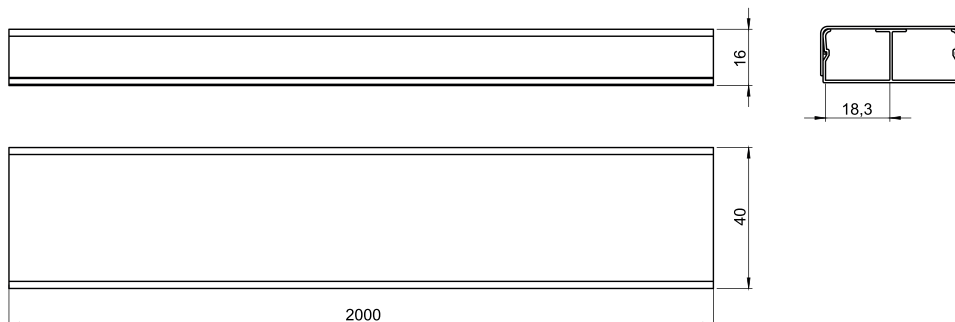

Accessories 40x16 mm

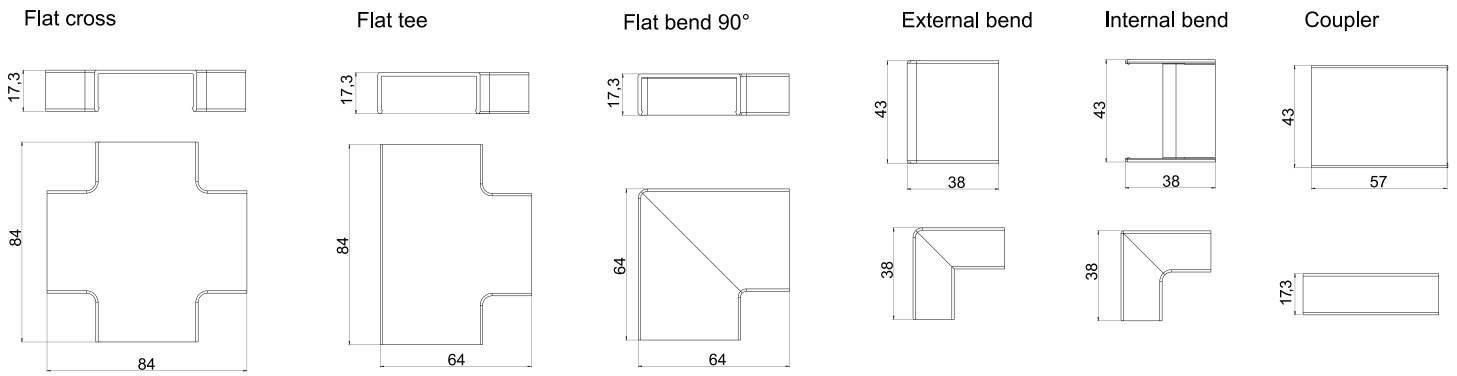

Flush-mounted to surface-mounted converter 4x2"

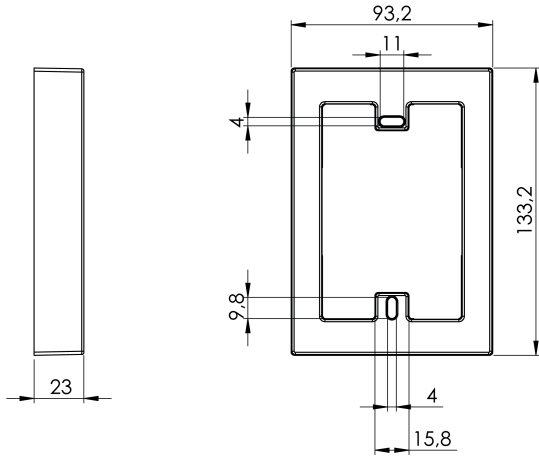

SELECTION GUIDE

Cable trunking and accessories

Product	Width mm	Height mm	Color
CAN	20	10	BR: White
CXC	40	16	PT: Black ¹
CXT			
CT9			
CTE			
CTI			
CLV			

¹The black color is only available on the 20x10 mm model.

Flush-mounted to surface-mounted converter ²

DRV-ES Product	4x2" Size	Color
		BR: White
		PT: Black

²Made of PS with Anti-UV additive.